

HANOVER®

Hanover Outdoor Furniture



IMPORTANT

If you have any problems with this product (missing or damaged parts, assembly issues, etc.),

PLEASE DO NOT RETURN TO THE RETAILER/STORE

from where you purchased the product.

Please call our Toll-Free Customer Service Hotline at: **1-800-416-3511**

Between 9:00 AM and 5:00 PM Eastern Time, Monday through Friday

Or visit our website at: **www.hanover-products.com**

To expedite any future warranty claims, please retain the Instruction Sheet, Warranty Card and receipt for future use.

For additional on-line support on assembly, troubleshooting and care & maintenance of your outdoor furniture, please visit our website at: **www.hanover-products.com**.

ASSEMBLY INSTRUCTIONS

1

Attach the seat frame to the back frame by using four 5/16"x40 mm bolts and washer as shown in *Figure 1*. Guide these bolts through the holes in the seat frame, into the fixed nuts already in place in the back frame. **Do not over tighten.**

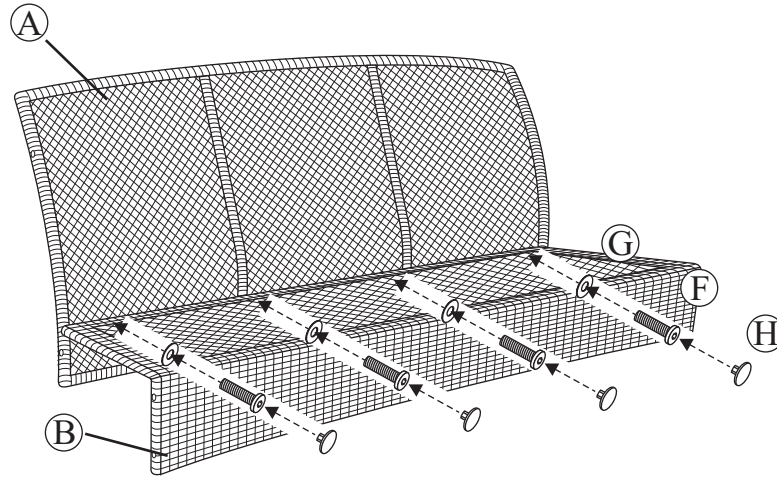

2

Attach love seat arm by inserting two 5/16"x25 mm bolts with washers through the holes in front seat portion of the love seat frame and into the holes in the love seat arm shown in *Figure 2*. Attach back of love seat arm by inserting two 5/16"x40 mm bolts with washers through holes in the back portion of love seat frame and into the holes in the rear portion of the love seat arm as shown in *Figure 2*. **Hand tighten only.** Repeat for the opposite side.

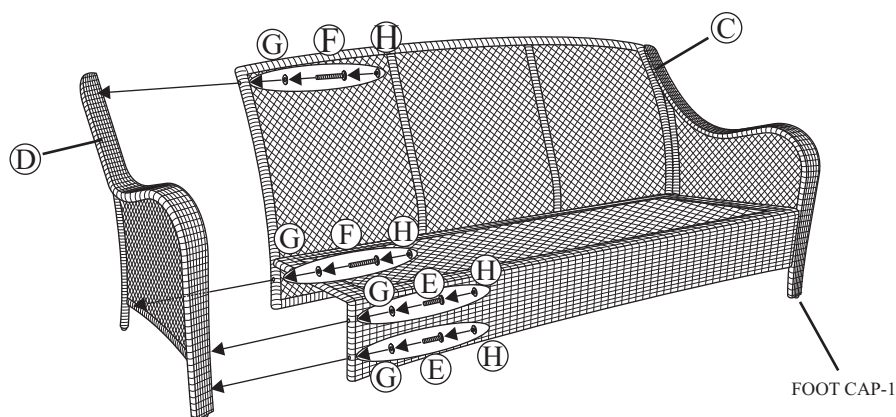







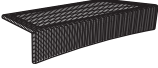
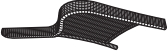

3

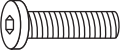
Tighten all bolts using the hex bolt driver provided. Tighten each bolt a few revolutions at a time, alternating between bolt connections until all bolts are tight. **Do not over tighten. Over tightening may strip bolts or damage the welds or frame.** Cover all bolts with bolt covers provided.

PARTS IDENTIFICATION LIST

** NOTE: PARTS SHOWN ON PARTS LIST ARE NOT TO SCALE*

	<u>PARTS LIST</u>	<u>DESCRIPTION</u>	<u>ORDER PART #</u>	<u>QTY</u>
A		BACK FRAME	SK0939	1
B		SEAT FRAME	SK0940	1
C		LEFT ARM	SK0941	1
D		RIGHT ARM	SK0942	1
E		5/16" X 25 MM BOLT	HW0186	4
F		5/16" X 40 MM BOLT	HW0275	8
G		Ø8.5 X 1.5 MM WASHER	HW0005	12
H		BOLT COVER	HW0022	12
I		HEX BOLT DRIVER	HW0006	1
		FOOT CAP-1 <i>FACTORY ASSEMBLY</i>	FC0030	
		FOOT CAP-2 <i>FACTORY ASSEMBLY</i>	FC0308	

BGC08006

ASSEMBLY INSTRUCTIONS

- 1 Assemble furniture on a smooth, non-abrasive surface. Attach the back frame to right arm by using two 5/16"x40 mm bolts and washers as shown in **Fig.1**. Guide the bolts through holes in back frame, into pre-drilled holes in the right arm. **Hand tighten only**. Attach the seat frame to right arm and back frame by using four 5/16"x25 mm bolts and washers as shown in **Fig.2**. **Hand tighten only**. Attach the left arm to back and seat frame by using two 5/16"x25 mm bolts and two 5/16"x40 mm bolts and four washers as shown in **Fig.3**. **Hand tighten only**.

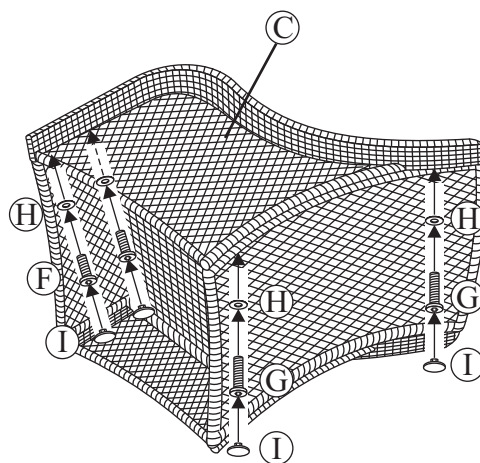
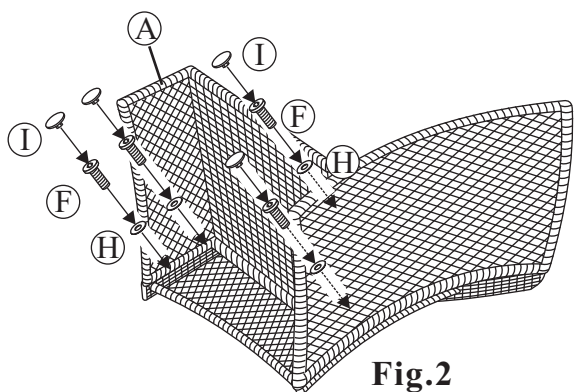
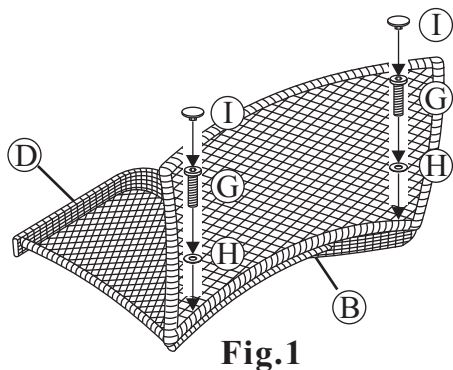

Fig.3

- 2 Attach the complete base to the complete seat by using four 5/16"x40 mm bolts and washers as shown in **Fig.4**. Guide the bolts through holes in base, into the pre-drilled holes in the seat. **Hand tighten only**.

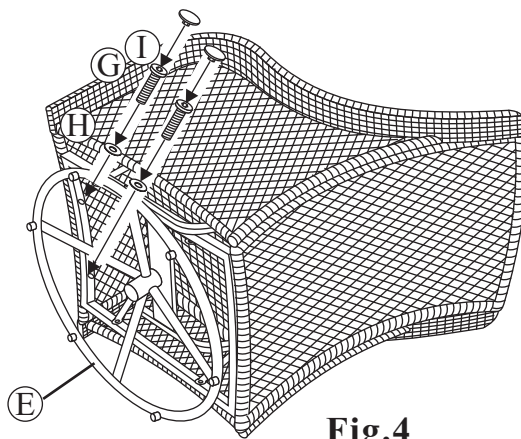

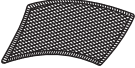

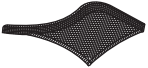

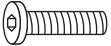



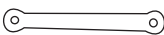
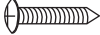



Fig.4

- 3 Using the hex bolt driver provided, tighten all bolts. **Do not over tighten bolts. If nuts and bolts are too tight or too loose, the glider will not function properly.** Test the operation of glider. Gliding motion should be smooth. Adjust tension on the glider brackets, nuts and bolts as needed. Cover nuts and bolts with covers provided.

PARTS IDENTIFICATION LIST

* NOTE: PARTS SHOWN ON PARTS LIST ARE NOT TO SCALE

	<u>PARTS LIST</u>	<u>DESCRIPTION</u>	<u>ORDER PART #</u>	<u>QTY</u>
A		SEAT FRAME	SG0154	1
B		BACK FRAME	SG0155	1
C		LEFT ARM	SG0156	1
D		RIGHT ARM	SG0157	1
E		GLIDER BASE W/ GLIDER BRACKET	SG0158 SG0159	1
F		5/16" X 25 MM BOLT	HW0186	6
G		5/16" X 40 MM BOLT	HW0275	8
H		Ø8.5 X 1.5 MM WASHER	HW0005	14
I		BOLT COVER	HW0105	14
J		HEX BOLT DRIVER	HW0006	1
		GLIDER BRACKET <i>FACTORY ASSEMBLY</i>	G0080	
		ST4.8 X 25 BOLT <i>FACTORY ASSEMBLY</i>	HW0695	
		FOOT CAP <i>FACTORY ASSEMBLY</i>	FC0013	

BGS12023